

bRite Advanced Retail scale

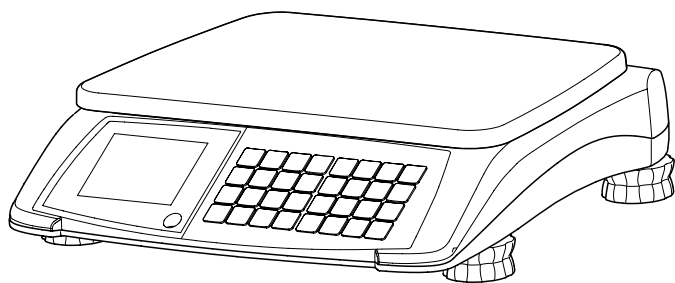

METTLER TOLEDO

Contents

1	Your new retail scale	5
1.1	Most important functions	5
1.2	Device overview	5
1.3	Safety instructions	8
1.4	Legal for trade	8
2	Setting up	9
2.1	Scope of delivery	9
2.2	Requirements for scale's location	9
2.3	Setting up the scale	9
2.4	Inserting the batteries	10
2.5	Connecting to mains power	11
2.6	Turning scale on/off	11
2.7	Cleaning	11
3	Operation	12
3.1	Free input	12
3.2	Working with PLUs	12
3.3	Using tare	16
3.4	Zeroing	17
3.5	By-count operation	17
3.6	Accumulating	18
3.7	Change function	19
3.8	Fix unit price and/or tare	20
3.9	Hold function	21
3.10	Weighing with 100 g (1/2 lb / 1/4 lb) price unit	21
3.11	Switching weighing unit between kg and lb	22
3.12	Displaying the price to pay in EURO	22
3.13	Backlight function	22
3.14	Ticket printing	23
3.15	Printing reports	25
4	Operator setup	27
4.1	Setup operation	27
4.2	Operator setup overview	28
4.3	Setting date and time	31
5	What do you do if...?	32

6	Technical data and accessories	33
6.1	Technical data	33
6.2	Accessories	33
6.3	Compliance	34
7	Appendix	35
7.1	Periodical verification in the countries of the EEC	35
7.2	Disposal	36

1 Your new retail scale

1.1 Most important functions

Congratulations on your new scale.

This robust digital price computing scale with its hygienic design and battery operation facilitates comfortable mobile selling while maintaining the highest accuracy.

POS connectivity provides external printing and/or data transfer with multiple protocols.

1.2 Device overview

The scale is available in two versions: as a compact scale or as a tower version.

1.2.1 Keyboard

The keyboard is divided into four sections. The advanced function keys depend on the region.

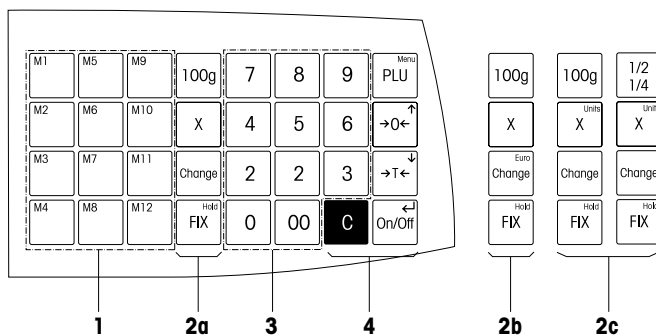

- 1 PLU preset keys
- 2a Advanced function keys, Basic (rest of the world)
- 2b Advanced function keys, Europe
- 2c Advanced function keys, 2 variants for North America
- 3 Numeric keypad
- 4 Basic function keys

Display

The display is laid out as follows from the customer and vendor point of view:

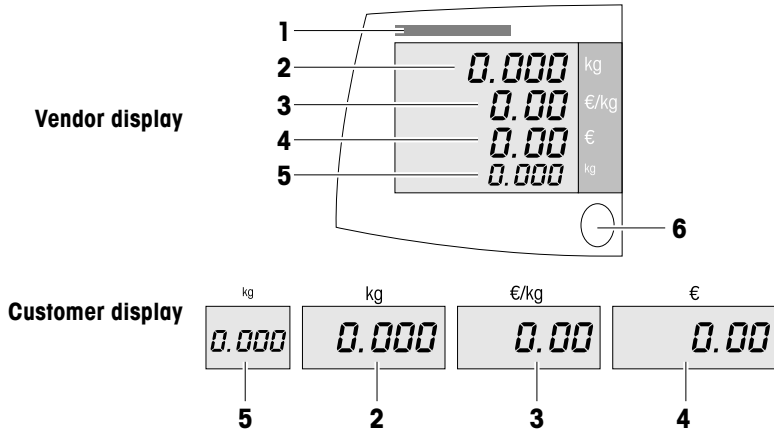

- 1 Calibration plate
- 2 Weight display
- 3 Unit price
- 4 Price
- 5 Preset fare
- 6 Level indicator

In addition to the weight and price, the following status messages and indicators can be displayed:

- ZERO** Scale is at center of zero
 - PT** Keyboard tare or tare recalled from PLU
 - NET** Net value (gross minus tare); push button tare exists
 - FIX** Unit price and/or tare is fixed
 - X** Scale is in by-count mode
 - 100 g** 100 g pricing is activated
 - 1/2** 1/2 lb pricing is activated
 - 1/4** 1/4 lb pricing is activated
 - Add** Scale is in accumulation mode; data exists in the accumulation memory
 - Total** The displayed total price is added into the accumulation memory
- Battery is approx. full
 - 2/3 battery power left
 - 1/3 battery power left
 - Battery power at a critical level

1.2.2

Connections and features on the underside

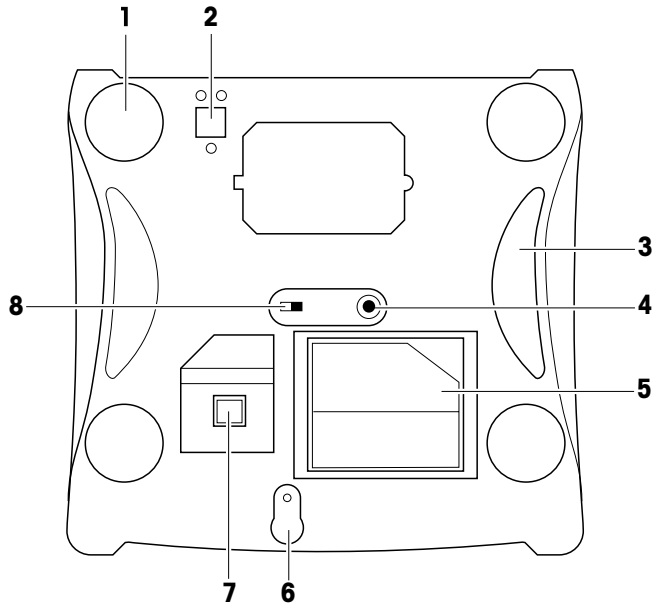

The following connections are located on the underside of the scale:

- 1** Adjustable feet
- 2** Tower mounting
- 3** Grips
- 4** Power supply connection
- 5** Power supply storage box
- 6** Calibration button
- 7** Interface connection; RS232/USB, depending on cable
- 8** Battery switch: NiMH – D-cell

1.3



Safety instructions

Basic safety instructions

- ▶ Read these operating instructions prior to using your scale.
- ▶ Store these operating instructions in the vicinity of the scale for future reference.
- ▶ Do not open the scale.
- ▶ Always unplug the scale before cleaning.



Safety instructions for battery operation

- ▶ The battery must not come into contact with chemical solvents, oil or water.
- ▶ Keep batteries away from heat and fire.
- ▶ Do not open the battery.

1.4

Legal for trade

When the scale is used in trade or a legally controlled application, it must be set up, verified and sealed in accordance with local weights and measures regulations. It is the responsibility of the purchaser to ensure that all pertinent legal requirements are met. As verification requirements vary by jurisdiction, the purchaser should contact their local weights and measures office if they are not familiar with the requirements.

For products sold in Europe, the verification process has been completed at the place of manufacture. These products have been sealed and the type plate includes supplemental metrology markings. They may be put into service immediately. If required by local W & M authorities, additional stickers will already be applied on the device.

For products sold in other regions, the verification process must be performed at the place of use.

To prevent access to calibration and metrological settings, the scale must be sealed using a paper seal or wire seal.

2 Setting up

2.1 Scope of delivery

- ▶ Check if the delivery is complete:
 - Scale
 - Stainless steel weighing pan
 - Power supply, stored in the power supply storage compartment under the scale
 - Operating instructions
 - Tower with mounting material, tower version only

2.2 Requirements for scale's location

The right location is critical to weighing accuracy.

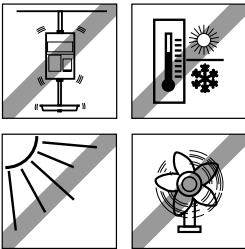

Conditions for an ideal location

- No shocks and vibrations
- No excessive temperature fluctuations
- No direct sunlight
- No strong drafts

- Select a stable, vibration-free and preferably horizontal location for your scale.

2.3 Setting up the scale

2.3.1 Levelling the scale

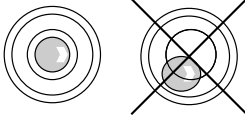

Only a perfectly levelled scale delivers accurate weighing results. The scale is equipped with a level indicator to make it easier to level the scale.

- ▶ To level the scale, turn the scale's adjustable feet until the air bubble in the level indicator is in the inner circle.

2.3.2

Mounting the tower

With the tower version the customer display is at eye level.
The tower must be mounted first.

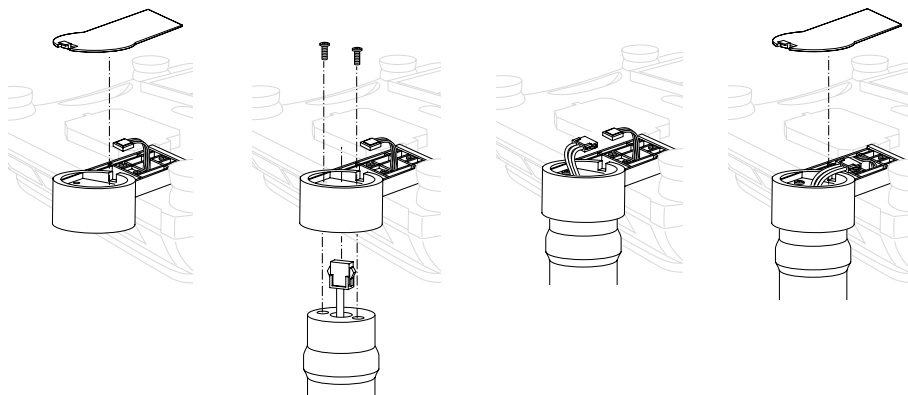

1. Remove the weighing pan and turn over the scale.
2. Open the tower base cover.
3. Route the cable from the tower through the tower base.
4. Put the tower on the tower base and fix it with two screws.
5. Clip the cable connectors together.
6. Put the cables and connectors in the tower base.
7. Close the tower base cover.
8. Turn over the scale and put the weighing pan back on.

2.4

Inserting the batteries

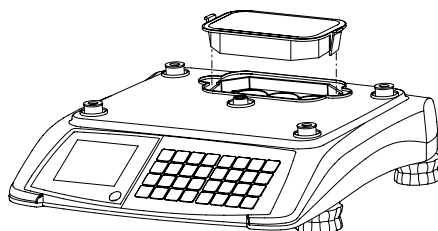

1. Make sure that the external power supply is disconnected.
2. Remove the weighing pan.
3. Remove the battery compartment cover.
4. Turn over the scale and set the battery switch as follows:
 - for rechargeable D-cell batteries: "NiMH".
 - for non-rechargeable D-cell batteries: "Battery"
5. Turn over the scale.



WARNING

Risk of explosion when the battery switch is not set correctly.

- ▶ Make sure that the battery switch is in the right position for the desired type of battery.
6. Place the batteries in the compartment so that the positive poles face the springs, see pole markings on cover and housing.
 7. Close the battery compartment and put the weighing pan back on.

2.5

Connecting to mains power

The power supply is stored in a department under the scale to support save transport.

1. Connect the supplied power supply unit to the power connection socket on the underside of the scale.
2. Plug the power supply unit into a correctly grounded power outlet.

2.6

Turning scale on/off

- ▶ To turn the scale on press the **On/Off** key.
- ▶ To turn the scale off press and hold the **On/Off** key until a long beep can be heard.



- After the scale is turned on, it runs through a short display test. All segments and status messages briefly light up, the software version is displayed.
- The scale is ready when the weight display appears.

2.7

Cleaning



CAUTION

Damage to the scale

- ▶ Turn off and unplug the device before cleaning.
- ▶ Do not open the device.
- ▶ Make sure that no fluids get inside the device.
- ▶ Do not use scouring powders or plastic dissolving cleaning agents for cleaning.

Cleaning

- ▶ Remove the weighing pan and clean it with a commercially available household detergent.
- ▶ If heavily soiled, clean the surface of the device with a damp cloth that has been dipped in water containing a mild liquid detergent and well wrung out.

3 Operation

3.1



0 ... 9

Free input

You can immediately use your scale for weighing and selling – without prior configuration.

1. Place the item on the scale.
2. Enter the unit price (price/kg).
The price to pay is displayed.
3. Remove the item from the scale.
All displays return to 0.



Enter the unit price as usual without the decimal point, but with all the decimal places.

3.2

Working with PLUs

You can save the price and/or tare for frequently sold goods in the scale's PLU memory and simply call it up later.

In the factory setting unit price and tare are saved in a PLU.

3.2.1

Creating a PLU

0 ... 9

PLU



P

0 ... 9



1. Enter the unit price (price/kg).
2. Press and hold the **PLU** key until a long beep can be heard.
P appears in the weight display.
3. Enter the PLU number (between 1 and 9999).
4. Wait until the scale beeps twice.
The PLU is stored and all displays return to 0.



- To save the tare weight in the PLU: before entering the unit price, first tare the corresponding container, see section 3.3.
- The scale can store 100 PLUs. If the memory is full and you want to store a new PLU the messages "Full" and "Delete" are displayed. You can either overwrite a specific PLU or delete the whole PLU memory.
 - To overwrite an existing PLU press the **C** key and create a new PLU with the number you want to overwrite.
 - To delete the whole PLU memory press the **Enter** (On/Off) key.

3.2.2

Calling up PLUs

Depending on the setting of operator setup Step 7, there are two ways to call up PLUs.



0 ... 9 **PLU**

Calling up via PLU key (factory setting, operator setup Step 7 = OFF)

1. Place the item on the scale.
2. Enter the corresponding PLU number and press the **PLU** key. Unit price and price to pay are displayed.
3. Remove the item from the scale. All displays return to 0.



0 ... 9

Calling up PLU automatically (operator setup Step 7 = ON)

1. Place the item on the scale.
2. Enter the corresponding PLU number. The PLU is called up automatically. Unit price and price to pay are displayed.
3. Remove the item from the scale. All displays return to 0.

3.2.3

Using PLU preset keys

You can save the most important PLUs to the keys in the left-hand key field.

Depending on the setting of operator setup Step 14, one or two PLUs can be assigned to a PLU preset key.

PLU preset keys with one PLU (operator setup Step 14 = OFF)

Storing one PLU to a preset key

1. Enter the unit price (price/kg) or recall PLU.
2. Press and hold the desired preset key, e.g., **M1**, until a long beep can be heard.
Two short beeps indicate that the data has been stored.

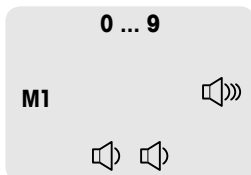

Calling up PLUs with preset keys

1. Place the item on the scale.
2. Press the corresponding preset key, e.g., **M1**.
Unit price and price to pay are displayed.
3. Remove the item from the scale.
All displays return to 0.

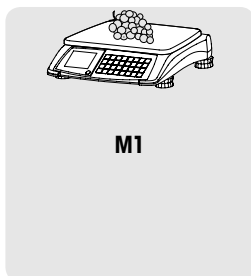

PLU preset keys with two PLUs (factory setting, operator setup Step 14 = ON)

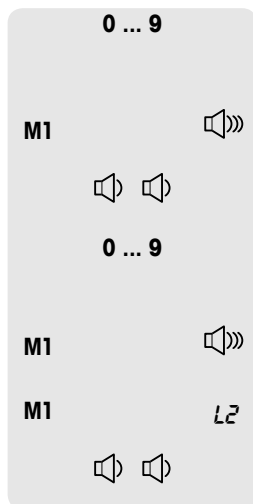

Storing two PLUs to a preset key

1. Enter the unit price (price/kg) or recall PLU of the **first** PLU to be assigned to the preset key.
2. Press and hold the desired preset key, e.g., **M1**, until a long beep can be heard.
Two short beeps indicate that the data has been stored.
3. Enter the unit price (price/kg) or recall PLU of the **second** PLU to be assigned to the preset key.
4. Press and hold the desired preset key, e.g., **M1**, until a long beep can be heard.
5. Immediately press the desired preset key again, e.g., **M1**.
L2 is displayed and two short beeps indicate that the data has been stored.

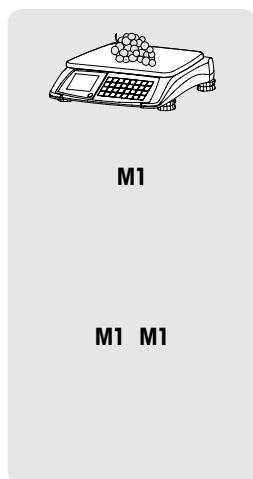

Calling up PLUs with preset keys

1. Place the item on the scale.
2. To call up the **first** PLU, press the corresponding preset key once, e.g., **M1**.
Unit price and price to pay of the first PLU are displayed.

or

To call up the **second** PLU, press the corresponding preset key twice, e.g., **M1**, **M1**.
Unit price and price to pay of the second PLU are displayed.
3. Remove the item from the scale.
All displays return to 0.

3.3

Using tare

You fill containers with your products or customers bring their own container. The tare function makes sure that only the goods are entered and paid.

If you know the weight of your containers, you can enter the tare weight via keyboard. So you do not have to tare the empty container.



...

Taring an empty container

1. Place the empty container on the scale.
2. Press the **Tare** key.
The weight display is reset to 0.000 kg and the NET symbol appears. The tare weight is displayed in the bottom line of the display.
3. Fill the container with the goods to be weighed.
4. Carry out pricing as described above.
5. Remove the container from the scale.
All displays return to 0.

Keyboard tare

0 ... 9



...

1. Input the known tare value and press the **Tare** key.
The input tare value is displayed in the bottom line of the display and the PT cursor is lit.
The weight display shows the negative tare value.
2. Place the item with container or wrapping material onto the scale.
3. Carry out pricing as described above.
4. Remove the item with container or wrapping material from the scale.
All displays return to 0.

3.4

Zeroing

Due to soiling on the weighing pan or unfavourable external influences, it is possible that the weight display of an unloaded weighing pan may no longer be 0.000 kg. In such cases, the scale must be reset to zero. The maximum allowed deviation to be compensated by zeroing is +/- 2 % of the weighing range.

0.0 10 kg



0.000 kg

- ▶ Press the **Zero** key.

The weight display is set to zero.

3.5

By-count operation

With the by-count function, you can price non-weighing items, e.g., in the bakery department.

0 ... 9



0 ... 9

1. Enter the unit price.
2. Press the **X** key to call up the by-count function. The by-count icon is displayed.
3. Enter the number of items (1 ... 99). The price to pay is displayed.



- The unit price is stored until by-count operation is ended.
- Use the **C** key to leave by-count operation.

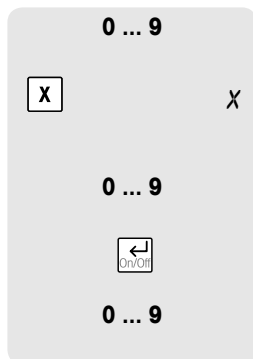

By-count operation (US version)

With the by-count function, you can price non-weighing items, e.g., in the bakery department. Pricing can base on a deal quantity of, e.g., 3 pieces.

1. Enter the deal quantity (1 ... 99).
 2. Press the **X** key to call up the by-count function. The by-count icon is displayed.
 3. Enter the price per deal quantity.
 4. Confirm with the **Enter** (On/Off) key.
 5. Enter the number of items (1 ... 99). The price to pay is displayed.
- The unit price is stored until by-count operation is ended.
 - Use the **C** key to leave by-count operation.

3.6

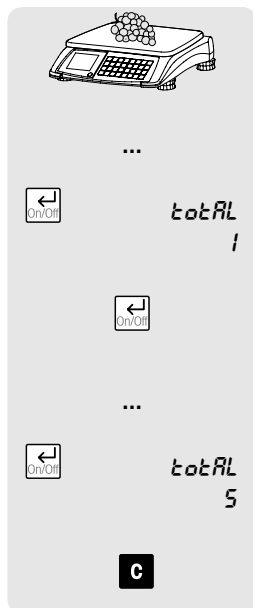

Accumulating

This functionality is only legal in certain regions or if the weighing system is connected to an external printer.

1. Place the first item on the scale.
2. Carry out pricing as described above.
3. Press the **Enter** (On/Off) key. The total price to pay and the number of items is displayed.
4. Remove the item and press the **Enter** (On/Off) key again. The weight display is shown.
5. Repeat steps 1 to 4 for more items.
6. To finish the transaction, press the **Enter** (On/Off) key. The total price to pay and the number of items is displayed.
7. To clear the total, press and hold the **C** key. The total is cleared.

If a printer is connected, a printout can be generated by pressing the **Enter** (On/Off) key twice. After printing, the total is cleared automatically.

3.7

Change function

Your scale is able to calculate the amount of change.

Single item

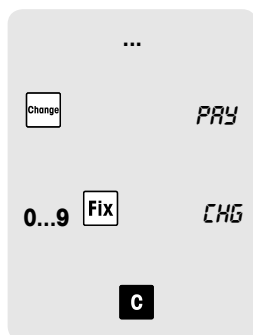

1. Carry out pricing as described above.
2. Press the **Change** key.
The total price to pay is displayed.
3. Enter the customer's payment and press the **FIX** key.
The amount of change is displayed.
4. Press the **C** key to return to normal weighing mode.

Multiple items

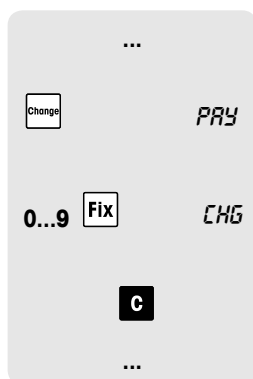

1. Carry out accumulating as described above.
2. When the total is displayed press the **Change** key.
The total price to pay is displayed.
3. Enter the customer's payment and press the **FIX** key.
The amount of change is displayed.
4. Press the **C** key to finish the change function.
5. Clear total as described above.

3.8

Fix unit price and/or tare

In normal operation, unit price and tare weight – if applicable – are cleared when the item is removed from the scale.

For weighing and pricing, several samples of the same PLU, e.g., for repackaging or sweet sales, you can fix unit price and/or tare.

Fixing price and tare weight

1. Tare the container as described above.
2. Place the first sample on the scale.
3. Carry out pricing as described above.
4. Press the **FIX** key.

When removing the item from the scale, the unit price and tare are still displayed.

5. Place the next sample on the scale.
The price to pay is displayed.
6. Remove the item from the scale.
7. Repeat steps 5 and 6 for more samples of the same unit price and tare.
8. Press the **FIX** key again to return to normal weighing mode.



...

Fix



3.99 E/KG



8.75 E

...

Fix



- To fix the price only, just begin with step 2.
- To fix the tare weight only, just leave out steps 2 and 3.

3.9

Hold function

When using the hold function, the price to pay is kept in the display when the item is removed from the scale.

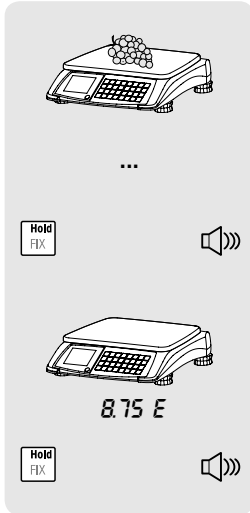

1. Place the item on the scale.
2. Carry out pricing as described above.
3. Press and hold the **Hold** (FIX) key until a long beep can be heard. Weight and unit price are cleared, the price to pay and "Hold" are displayed.
4. When removing the item from the scale, the price to pay is still displayed.
5. To return to normal weighing mode, press and hold the **Hold** key again until a long beep can be heard.

3.10

Weighing with 100 g (1/2 lb / 1/4 lb) price unit

For many products, customers are used to a price per 100 g (1/2 lb / 1/4 lb).

This function is only available if permitted by the national W & M regulations.

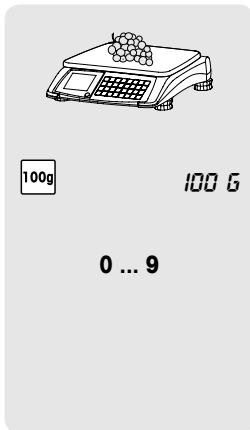

1. Place the item on the scale.
2. Press the **100 g** (1/2 lb / 1/4 lb) key. The icon 100 g (1/2 lb / 1/4 lb) is displayed.
3. Enter the unit price per 100 g (1/2 lb / 1/4 lb). The unit price per 100 g (1/2 lb / 1/4 lb) and the price to pay are displayed.
4. Remove the item from the scale. All displays return to 0.



100 g (1/2 lb / 1/4 lb) mode stays active until the **100 g** (1/2 lb / 1/4 lb) key is pressed again.

3.11

Switching weighing unit between kg and lb

This function is only available if permitted by the national W & M regulations.

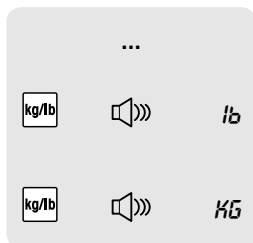

1. Carry out pricing as described above.
2. Press the **Units** key until a long beep is can be heard. The weight is displayed in the second weight unit.
3. Press the **Units** key again until a long beep can be heard to return to the first weight unit.

3.12

Displaying the price to pay in EURO

Depending on the setting of operator setup Step 10, the price to pay can be converted, e.g., from EURO to the old local currency. This function is only available if permitted by the national W & M regulations.

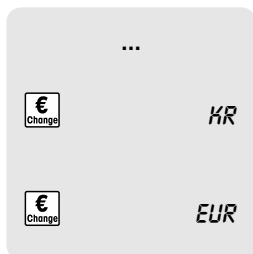

1. Carry out pricing as described above.
2. Press the **EUR** key. The price to pay is displayed in the second currency.
3. Press the **EUR** key again to return to the first currency.

3.13

Backlight function

If the light of the environment is not bright enough to get a clear reading from the display, the backlight can be switched on.

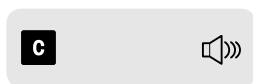

Switching backlight on/off

- ▶ Press and hold the **C** key until a long beep can be heard. The backlight is switched on/off.



When the scale is not used for 15 seconds, the backlight automatically switches off. When a weight is placed on the scale or when a key is pressed, the backlight switches on again.

3.14 Ticket printing

Your scale provides an interface to connect a printer.
For ticket printing, operator setup Step 16 must be set to "1".

3.14.1 Ticket without VAT

For ticket printing without VAT, operator setup Step 21 must be set to "OFF".

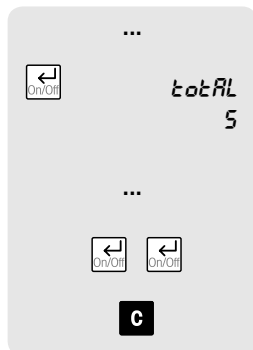

1. Carry out accumulating as described above.
2. To finish the transaction, press the **Enter** (On/Off) key.
The total price to pay and the number of items are displayed.
3. If desired, enter the amount of change as described above.
4. To initiate printing, press the **Enter** (On/Off) key twice.
5. Press the **C** key to cancel the transaction.

Printout example

TickNr 25		
2010-10-10 10:10		

PLU TEXT		
kg (pcs)	€/kg(pcs)	€

PLU 5		
0.110	45.67	5.02
Preset 1		
1.165	4.56	5.31
Non PLU		
5	0.95	4.75

Total	15.08	
Cash		
	20.00	

Change	4.92	

3.14.2

Ticket with VAT

For ticket printing with VAT, operator setup Step 21 must be set to "ON" (factory setting).

Storing VAT on a key

To store a VAT on the keys **M9** to **M12**, operator setup Step 22 must be set to "1".

M9 ... M12

0 ... 9



1. Press and hold one of the keys **M9** to **M12** until a long beep can be heard.
2. Enter VAT rate and confirm with the **Enter** (On/Off) key.
E.g., enter 7.00 for VAT rate 7%.

Printing a ticket with VAT

1. Carry out pricing as described above.
2. Press the corresponding VAT key (**M9** to **M12**).
3. Repeat steps 1 and 2 for further items.
4. To finish the transaction, press the **Enter** (On/Off) key.
The total price to pay and the number of items are displayed.
5. If desired, enter the amount of change as described above.
6. To initiate printing, press the **Enter** (On/Off) key twice.
7. Press the **C** key to cancel the transaction.

...

M9 ... M12

...



total
5

...



C

Printout example

TickNr 25		
2010-10-10 10:10		

PLU TEXT		
kg (pcs)	€/kg(pcs)	€

PLU 5		
0.110	45.67	5.02
Preset 1		
1.165	4.56	5.31
Non PLU		
5	0.95	4.75

Total	15.08	
Tax	7.00 %	0.72
Tax	19.00 %	0.85

Cash	20,00	

Change	4.92	

3.15 Printing reports

3.15.1 Printing sales report

M5



- ▶ Press the report button **M5** and confirm with the **Enter** (On/Off) key.

The sales report is printed.

When printing is finished you are asked if you want to delete the sales report.

DELETE

Sales report example

Sale Report		
Report number 25		
Start time	2010-10-10	20:53
To time	2010-10-16	21:02
Item	kg/pcs/time	€
By Weight	35.378	323.79
By Count	145	691.56
PLU Sales		923.44
Non PLU		191.91
Sales Total		1115.35
Tax		127.89

3.15.2

Printing Log report

M5 M5 

DELETE

1. Press the report button **M5** twice and confirm with the **Enter** (On/Off) key.
2. Select the range of transactions to be printed.

The log report is printed.

When printing is finished you are asked if you want to delete the transactions.

Log report example

Sale Log		
Ticket number 25		
2010-10-10 10:10		
Item	kg/pcs/time	€
PLU 5	0.110	5.02
Preset 1	1.165	5.31
Non PLU	5	4.75

Sale Log		
Ticket number 26		
2010-10-10 10:13		
Item	kg/pcs/time	€
PLU 3	0.155	15.02
Non PLU	3	2.97
Preset 2	1.855	7.39

...		

4 Operator setup

4.1 Setup operation

4.1.1 Entering operator setup

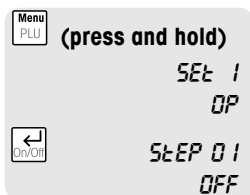

1. Press and hold the **Menu** (PLU) key until a long beep can be heard. SET 1 OP is displayed for "Operator Setup"
2. Press the **Enter** (On/Off) key to enter operator configuration. The first operator setup step and its current setting are displayed.

4.1.2 Navigation in the setup

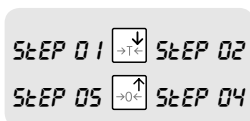

Selecting setup step

- ▶ To move to another setup step, use the **Arrow down** (Tare) key or **Arrow up** (Zero) key. In the line below, the current setting of the step is displayed.

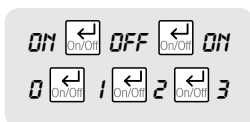

Changing settings

- ▶ To toggle between the settings of a setup step, use the **Enter** (On/Off) key. When moving to another setup step, the selected setting is confirmed.

4.1.3 Ending setup



1. Press the **Menu** (PLU) key to leave operator setup steps.
2. Press the **Menu** (PLU) key again to leave the setup mode. SAVE is displayed.
3. If you do not want to save, use the **Enter** (On/Off) key to toggle between SAVE and ABORT.
4. Press the **Menu** (PLU) key a third time to return to the weighing mode.

4.1.4

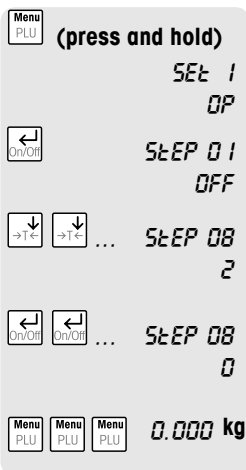
**Example: Setting digital filter to low (operator setup Step 8 = 0)**

1. Press and hold the **Menu (PLU)** key until a long beep can be heard. SET 1 OP is displayed for "Operator Setup".
2. Press the **Enter (On/Off)** key to enter operator configuration. The first operator setup step and its current setting are displayed.
3. To move to setup Step 8, press the **Arrow down (Tare)** key repeatedly until Step 08 with its current setting is displayed.
4. To change the setting of setup Step 8, press the **Enter (On/Off)** key repeatedly until the setting is 0.
5. End setup by pressing the **Menu (PLU)** key three times.

4.2

Operator setup overview

Factory settings are indicated in **bold** print.

No. Setting Description**1 Reset**

- ON Reset operator setup functions to factory settings
OFF Do not reset operator setup functions

2 Beeper

- ON** Beep when a key is pressed
 OFF No sound when a key is pressed

3 Backlighting

- ON Backlighting on
OFF Backlighting off

4 Power off / sleep

- 0 Both disabled, power off and sleep function
 1 No sleep function, automatic power off after 30 minutes of non-use
 2 Sleep function after 5 minutes of non-use, no automatic power off
 3 Sleep function after 5 minutes of non-use, automatic power off after 30 minutes of non-use
 4 Sleep function after 15 minutes of non-use, no automatic power off
5 Sleep function after 15 minutes of non-use, automatic power off after 30 minutes of non-use

No.	Setting	Description
5	Auto clear tare	
	ON	Automatic clearing of the tare weight when the load is removed from the platform
	OFF	No automatic clearing of the tare weight
6	Prepack / fix mode	
	ON	Prepack / fix mode enabled
	OFF	Prepack / fix mode disabled
7	Auto PLU	
	ON	Find PLU as soon as a number is entered
	OFF	Find PLU after pressing the PLU key
8	Digital filter	
	0	Low digital filtering
	1	Medium digital filtering
	2	High digital filtering
9	Charging function	
	ON	Battery charging function enabled
	OFF	Battery charging function disabled
		To change charging function you are asked to enter a password: 55555
10	Function keys	
	0	Function keys disabled
	1	Function keys enabled
11	PLU	
	ON	Storing PLUs enabled
	OFF	Storing PLUs disabled
12	By-count operation	
	ON	By-count operation enabled
	OFF	By-count operation disabled
13	Euro	
	1	Only the local currency is displayed
	2	You are asked to enter the conversion rate from the local currency into EUR. When pressing the EUR key, the local currency is converted into EUR.
	3	You are asked to enter the conversion rate from EUR into the local currency. When pressing the EUR key, EUR is converted into the local currency.
	4	Only EUR is displayed.

No. Setting Description**14 Two PLUs in one preset key**

- ON** Two PLUs can be preset in one preset key
OFF Only one PLU can be preset in a preset key
-

15 Communication port

- 0** RS232
1 USB
-

16 Communication type

- 0** Protocol transfer to a connected computer
1 Printout on a connected printer
-

17 Ticket language

- 0** English
1 French
2 German
3 Spanish
4 Italian
-

18 RS232 communication speed

- 0** 1200 bps
1 2400 bps
2 4800 bps
3 9600 bps
4 19200 bps
5 38400 bps
6 57600 bps
-

19 Communication format

- 0** 7 data bits, parity even, 1 stop bit
1 7 data bits, parity odd, 1 stop bit
2 7 data bits, no parity, 1 stop bit
3 8 data bits, no parity, 1 stop bit
4 7 data bits, parity even, 2 stop bits
5 7 data bits, parity odd, 2 stop bits
6 7 data bits, no parity, 2 stop bits
7 8 data bits, no parity, 2 stop bits
-

No.	Setting	Description
20	Price computing protocol type	
0	CAS	
1	Avery Berkel	
2	Dialog 06	
3	L2 Mettler Toledo	
4	Anker	
5	Dialog 02/04	
6	NCI Protocol	
21	VAT	
ON	Price is with VAT	
OFF	Price is without VAT	
22	VAT key	
0	VAT key disabled	
1	VAT key enabled	
23	PLU tare	
ON	Storing unit price and tare weight in the PLU	
OFF	Storing unit price only in the PLU	

4.3

Setting date and time

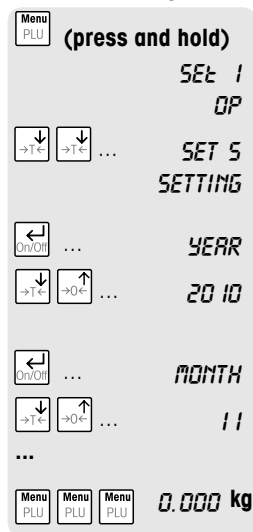

1. Press and hold the **Menu** (PLU) key until a long beep can be heard.
2. Press the **Arrow down** (Tare) key repeatedly until SET 05 SETTING is displayed.
3. Press the **Enter** (On/Off) key to set the year.
4. Use the **Arrow down** (Tare) key or **Arrow up** (Zero) key to change the year.
5. Repeat steps 3 and 4 to set month, day, hour, minute and second.
6. End setup by pressing the **Menu** (PLU) key three times.

5 What do you do if....?

General

If the scale shows an error message, proceed as follows:

1. Turn off the scale and wait for approx. 5 seconds.
2. Turn on the scale.
3. If the error message is still displayed, refer to the error message list.

Error message list

Error	Cause	Remedy
E11	RAM error	▶ Call service technician
E16	ROM error	▶ Call service technician
E18	EEPROM error	▶ Call service technician
E34	PLU No. too high	▶ Enter PLU No. from 1 to 99
No PLU	PLU not found	▶ Store PLU
nnnnnn	Overload	▶ Reduce load
uuuuuu	Load too small	▶ Re-zero the scale

6 Technical data and accessories

6.1 Technical data

Display

Weight display	6 digits
Unit price display	6 digits
Total price display	7 digits

Ambient conditions

Operating temperature	-10 °C to +40 °C
Storage temperature	-25 °C to +50 °C

Electrical data

Power supply	12 V DC
Power consumption	50 mA
Plug-in adapter	In: 230 V AC 50 Hz Out: 12 V DC / 800 mA
Charging current	500 mA
NiMH battery capacity	7000 mAh

Interface

1 connector on the under-side	RS232C or USB, depending on the interface cable
-------------------------------	---

6.2 Accessories

The following optional accessories are available from your sales representative:

- Weighing platform cover
- Scale cover
- POS connector RS232
- POS connector USB
- External printer
- Deep bowl
- Rechargeable NiMH batteries
- Printer cable



The offering of accessories may vary by the region.

6.3**Compliance**

Compliance to the following standards is indicated by the corresponding mark on the product.

This product conforms to the EMC directive 2014/30/EU, the Low Voltage Directive 2014/35/EU and the Non-automatic Weighing Instruments Directive 2014/31/EU. The complete Declaration of Conformity is available online at

<http://www.mt.com/retail-manuals>

7 Appendix

7.1 Periodical verification in the countries of the EEC

Country	Period	Date on seal	Verification body	Note
Austria	2 years	Year	MT	W&M if no private body accredited
Belgium	4 years	Year	W&M	
Bulgaria	1 year class III	Month	W&M	
Croatia	1 year	Quarter	W&M	
Czech Republic	2 years	Year	W&M	
Denmark	4 years	Year	Force, MT	MT as of 2009
Estonia	1 year	Month	Metroserf	
Finland	3 years	Year	W&M	
France	2 years	Month	MT	
Germany	2 years	Year	W&M	
Greece	1 year	Year	W&M	
Hungary	2 years	Exact day	W&M	
Iceland	2 years	Year	W&M	
Ireland	1 year	Exact day	W&M	
Italy	3 years	Month	MT	
Latvia	2 years	Year	W&M	
Lithuania	2 years	Year	W&M	
Netherlands	None	–	MT	Random checks by W&M
Norway	3 years	Year	W&M	
Poland	4 years / 25 months	Year / Month	W&M	4 years after initialisation, 25 months on periodic
Portugal	1 year	Year	W&M	
Romania	1 year	Month	W&M	
Slovakia	2 years	Exact day	W&M	
Slovenia	2 years	Exact day	W&M	
Spain	2 years	Year	W&M	
Sweden	2 (1) years	Year	W&M	1 year when used out-doors
Switzerland	2 years	Year	W&M	
United Kingdom	None	–	W&M	Random checks by W&M

7.2**Disposal**

In accordance with the requirements of European Directive 2002/96 EC on Waste Electrical and Electronic Equipment (WEEE), this device may not be disposed of with domestic refuse. This also applies for countries outside the EU in accordance with their respective national regulations.

- ▶ Please dispose of this product in accordance with local regulations for the separate collection of waste electrical and electronic equipment.

Should you have any questions, please contact the corresponding authorities or the dealer from whom this device was purchased.

If this device is passed on (for example for further private or commercial/industrial use), this regulation is also to be passed on.

Many thanks for your contribution to the protection of the environment.

Battery disposal Batteries contain heavy metals and therefore cannot be disposed of in the domestic refuse.

- ▶ Observe local regulations on the disposal of materials which are hazardous to the environment.

www.mt.com/retail

For more information

Mettler-Toledo GmbH

Im Langacher 44
8606 Greifensee, Switzerland
www.mt.com/contact

Subject to technical changes.
© Mettler-Toledo GmbH 08/16
30209977C en



* 3 0 2 0 9 9 7 7 C *